

# Israeli Air Force

# F-15I Ra'am



Photo: Amit Agronov - IAF Magazine ©



69 Squadron



Manat - Test  
& Evaluation  
Unit

# IsraDecal

THE COMPLETE SCALE MODELLING EXPERIENCE



Also available from our website:  
[www.isradecal.com/instructions](http://www.isradecal.com/instructions)

**IsraDecal**   
STUDIO

[www.isradecal.com](http://www.isradecal.com)

# Front right side fuselage

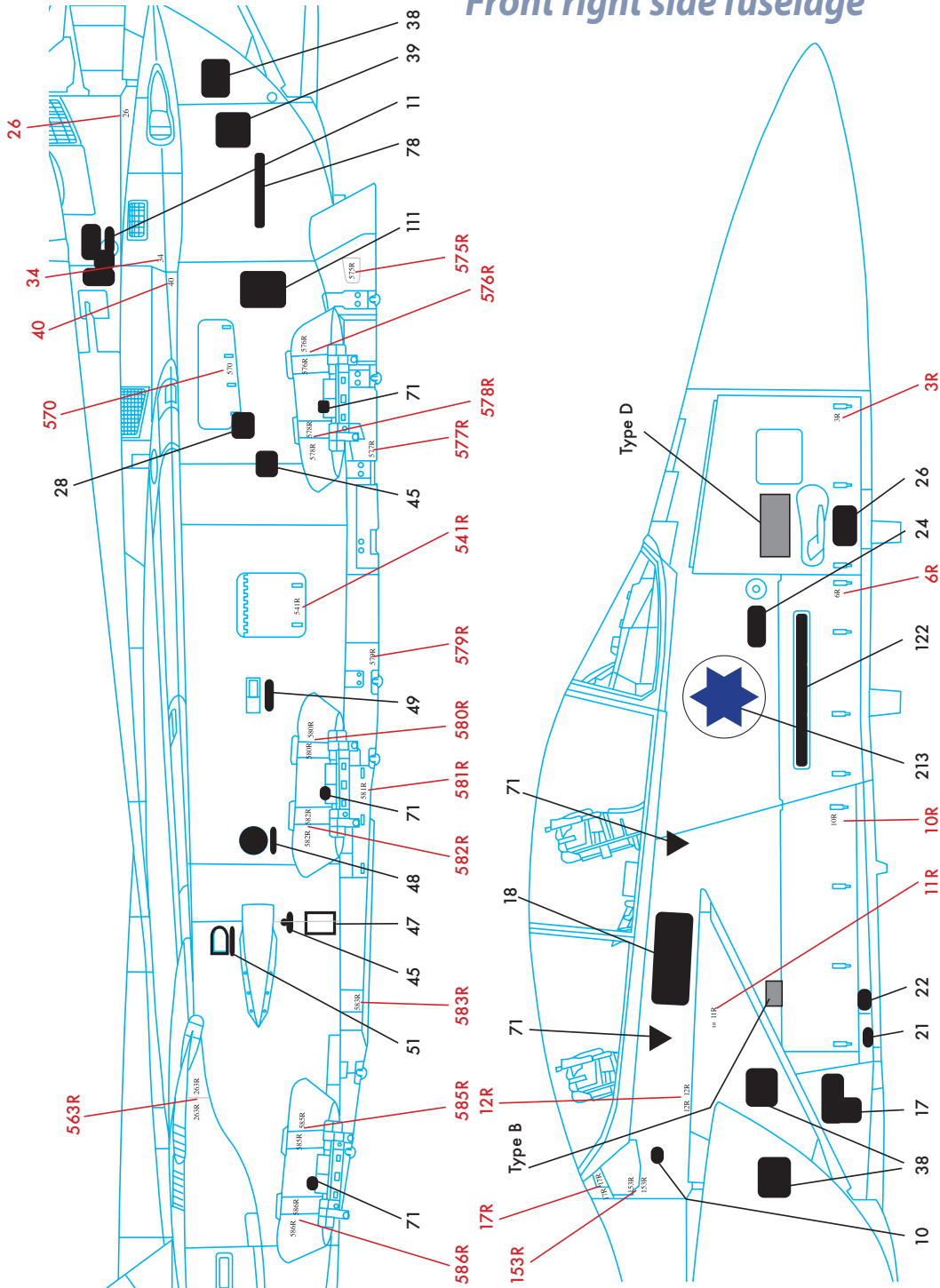

# Aft right side fuselage & rudder

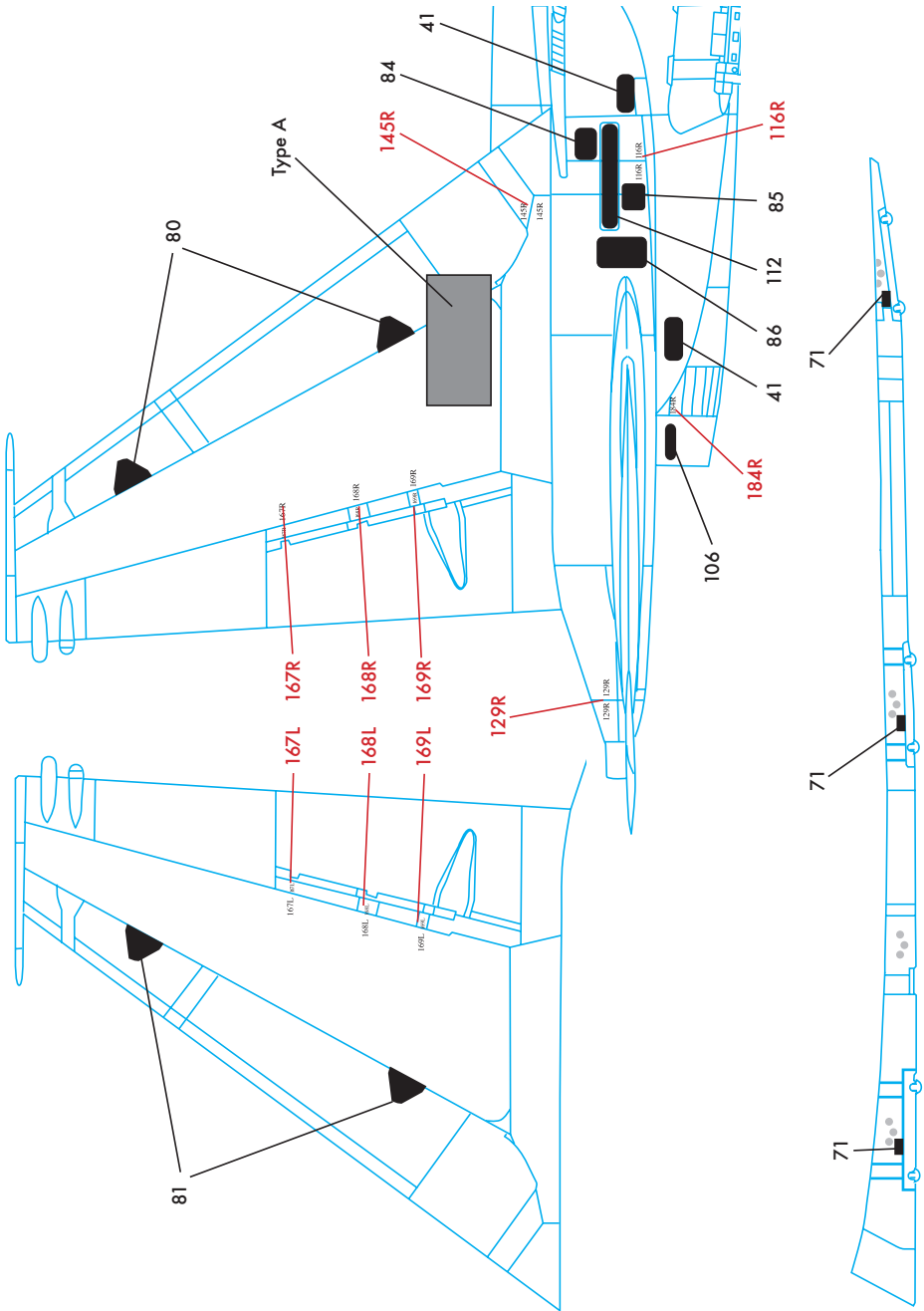

# Front left side fuselage

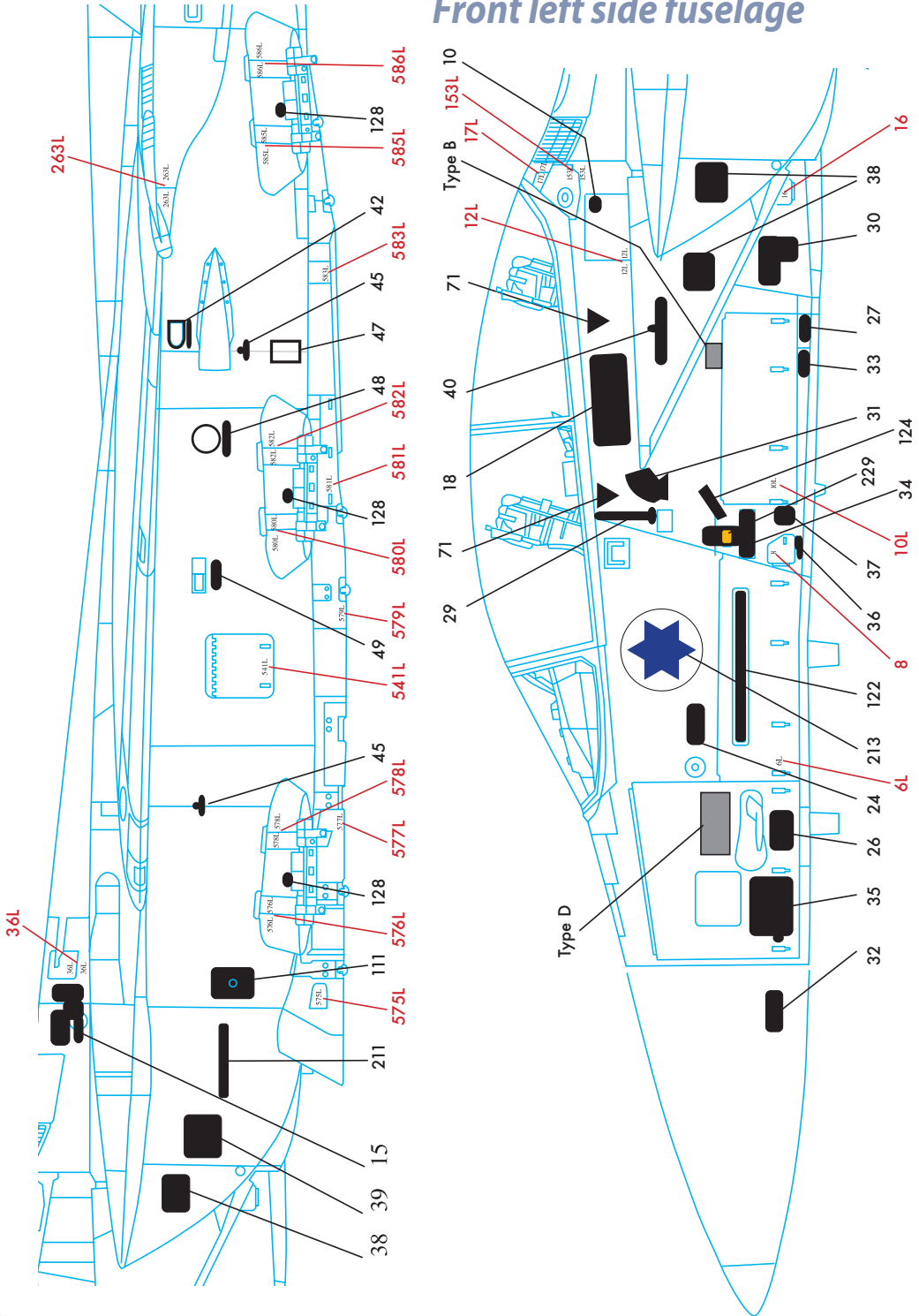

# Aft left side fuselage & rudder

34 or  
34+124

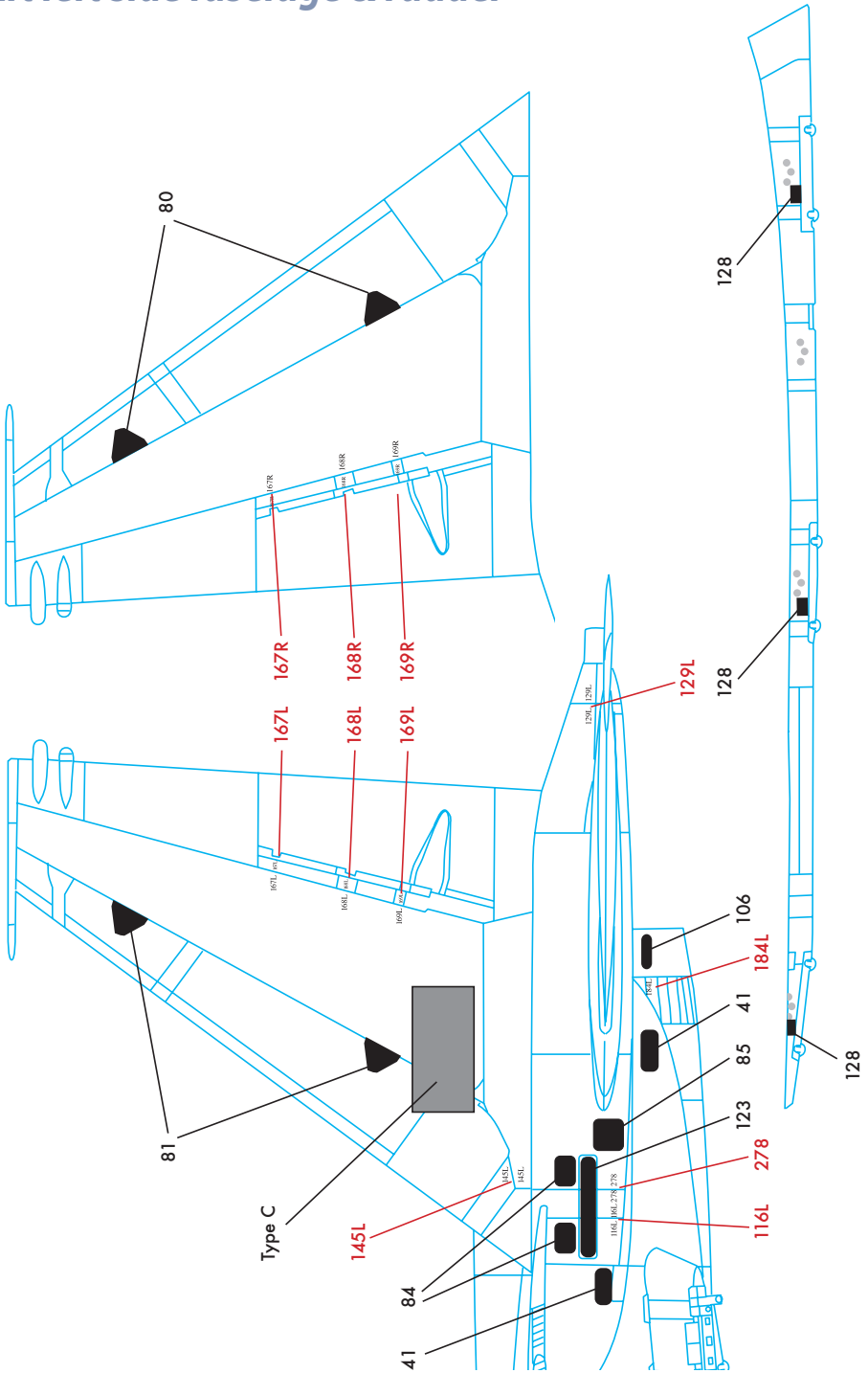



# Right wing

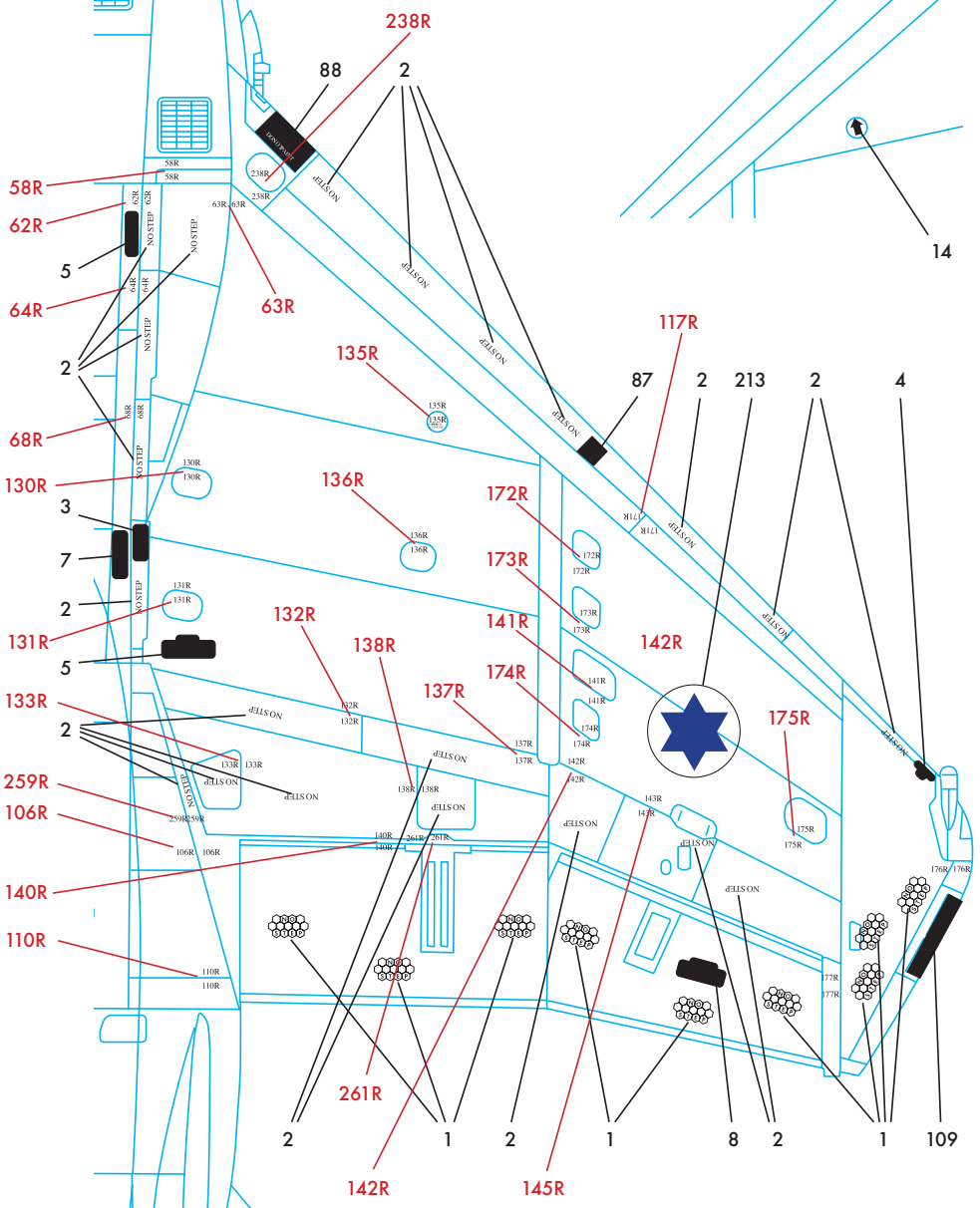

# Aft top side - stencils & panel numbers placement

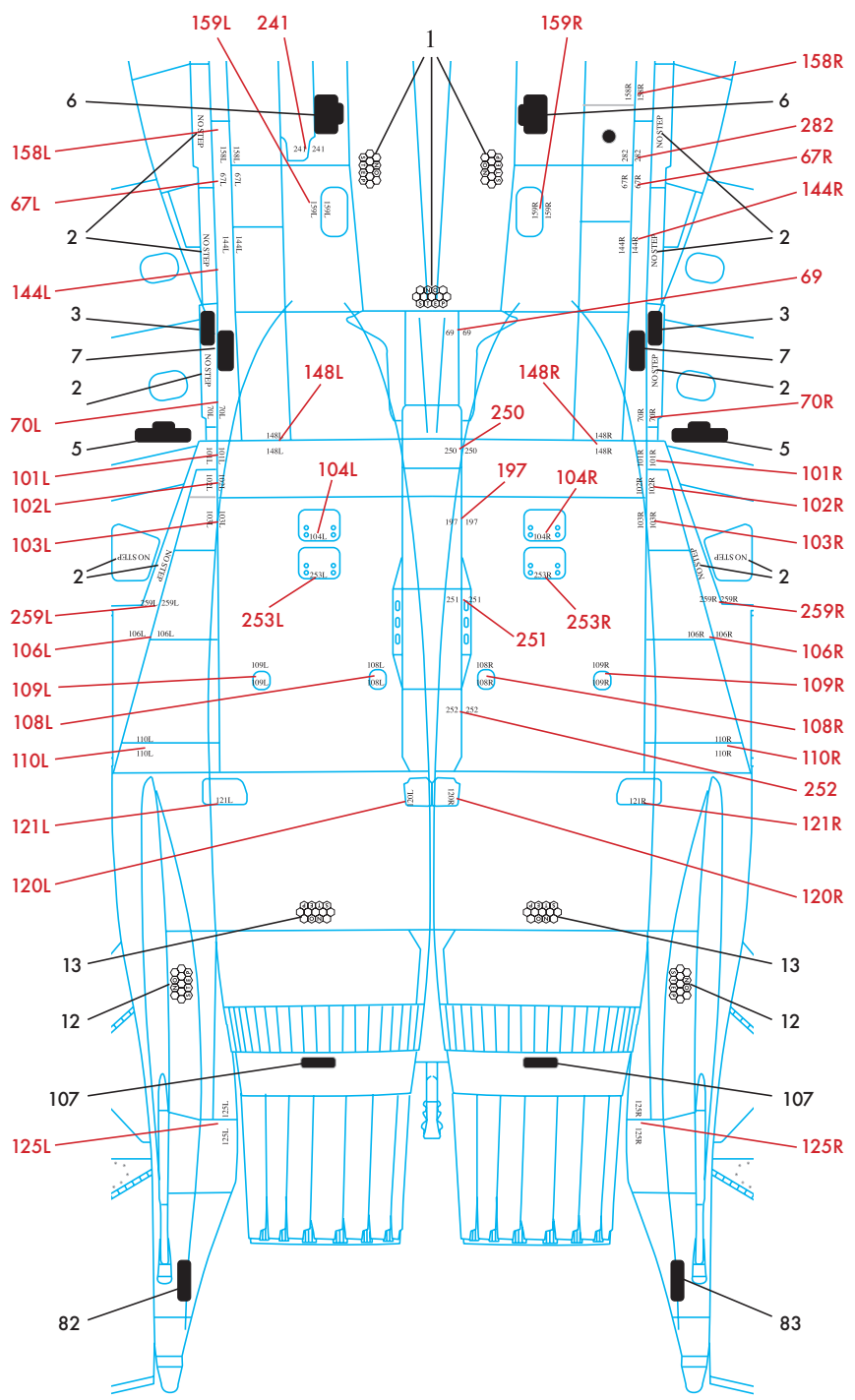



# Front top side - stencils & panel numbers placement

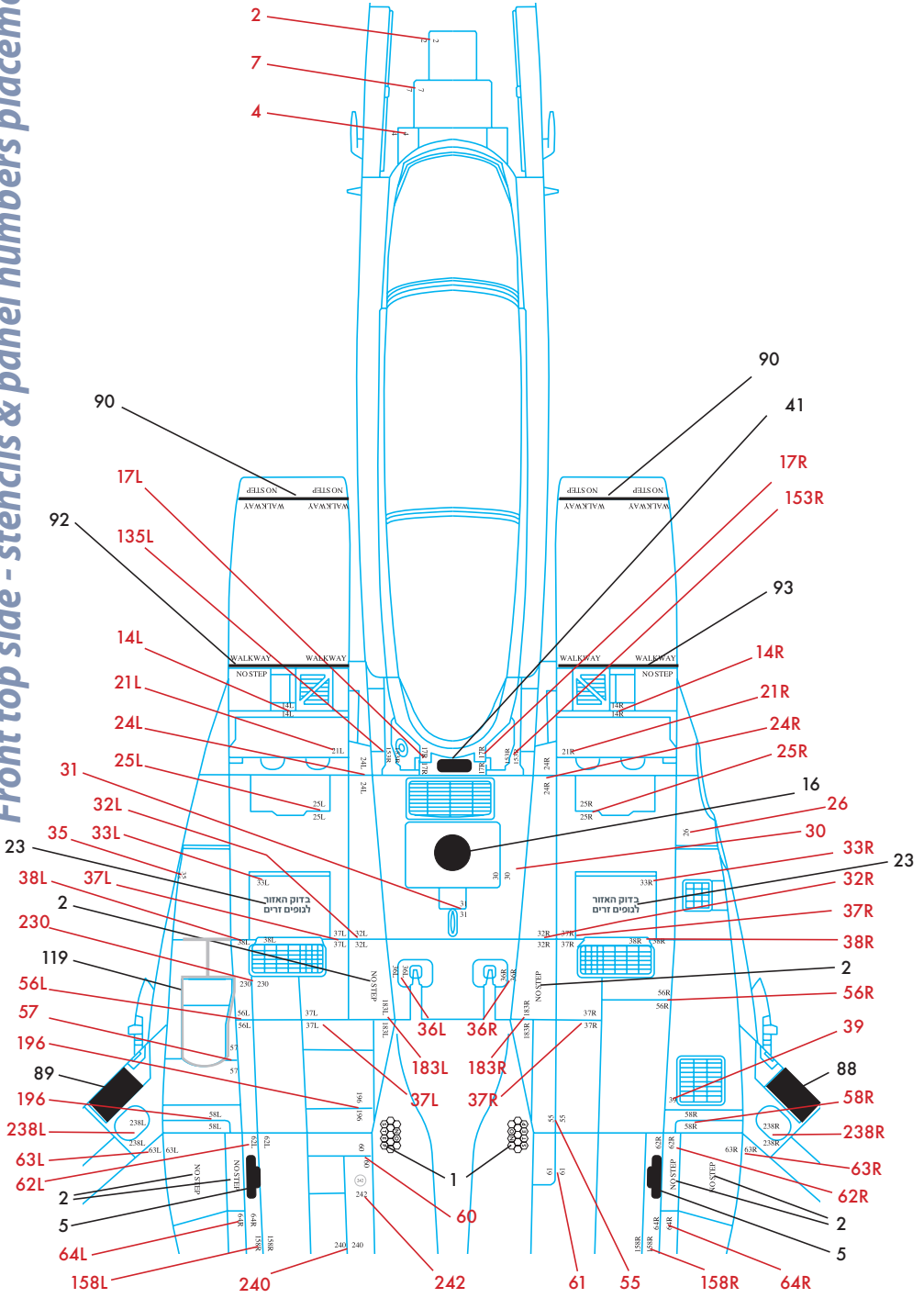

# Aft bottom side - stencils placement

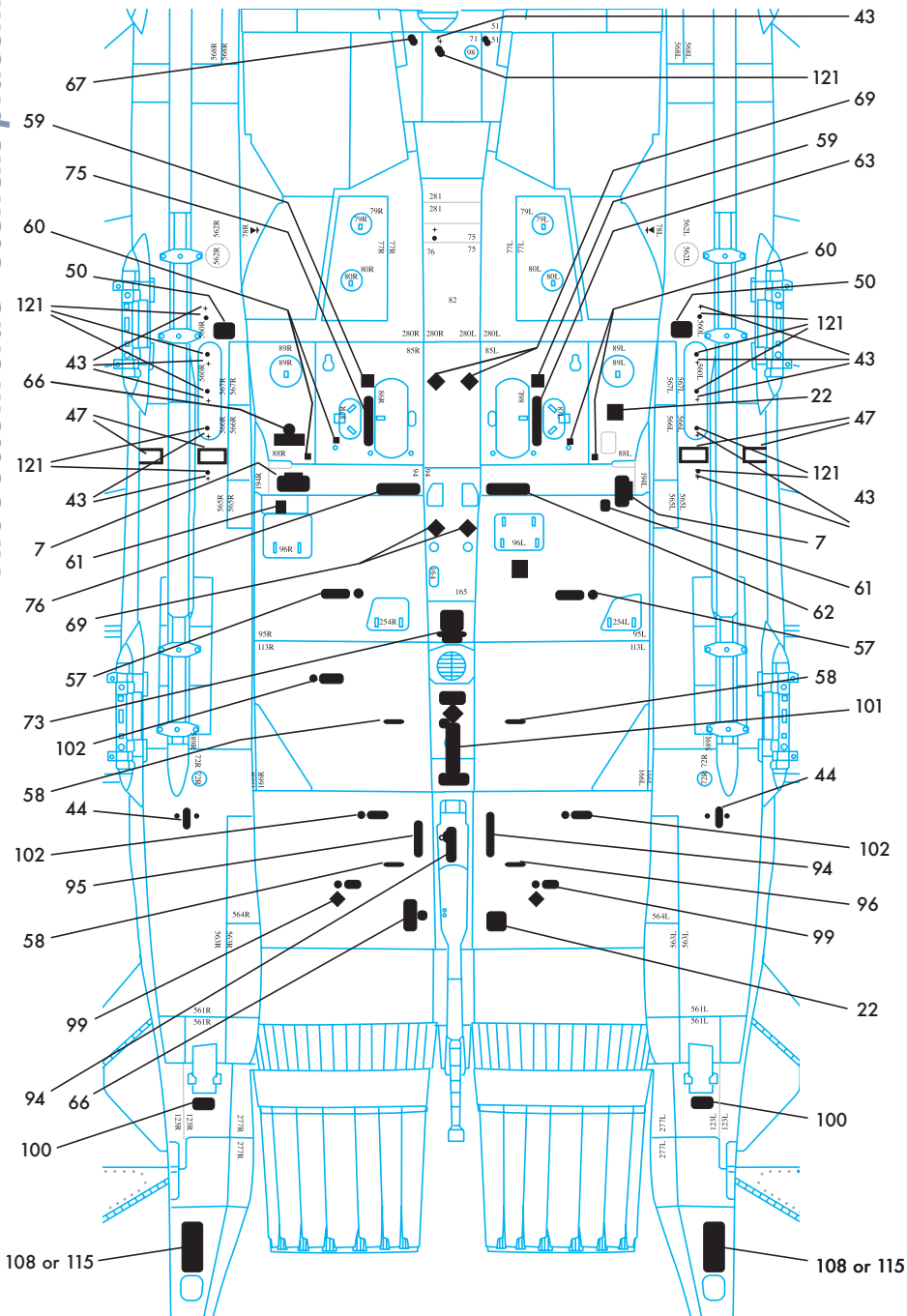

# Aft bottom side - Panel numbers placement

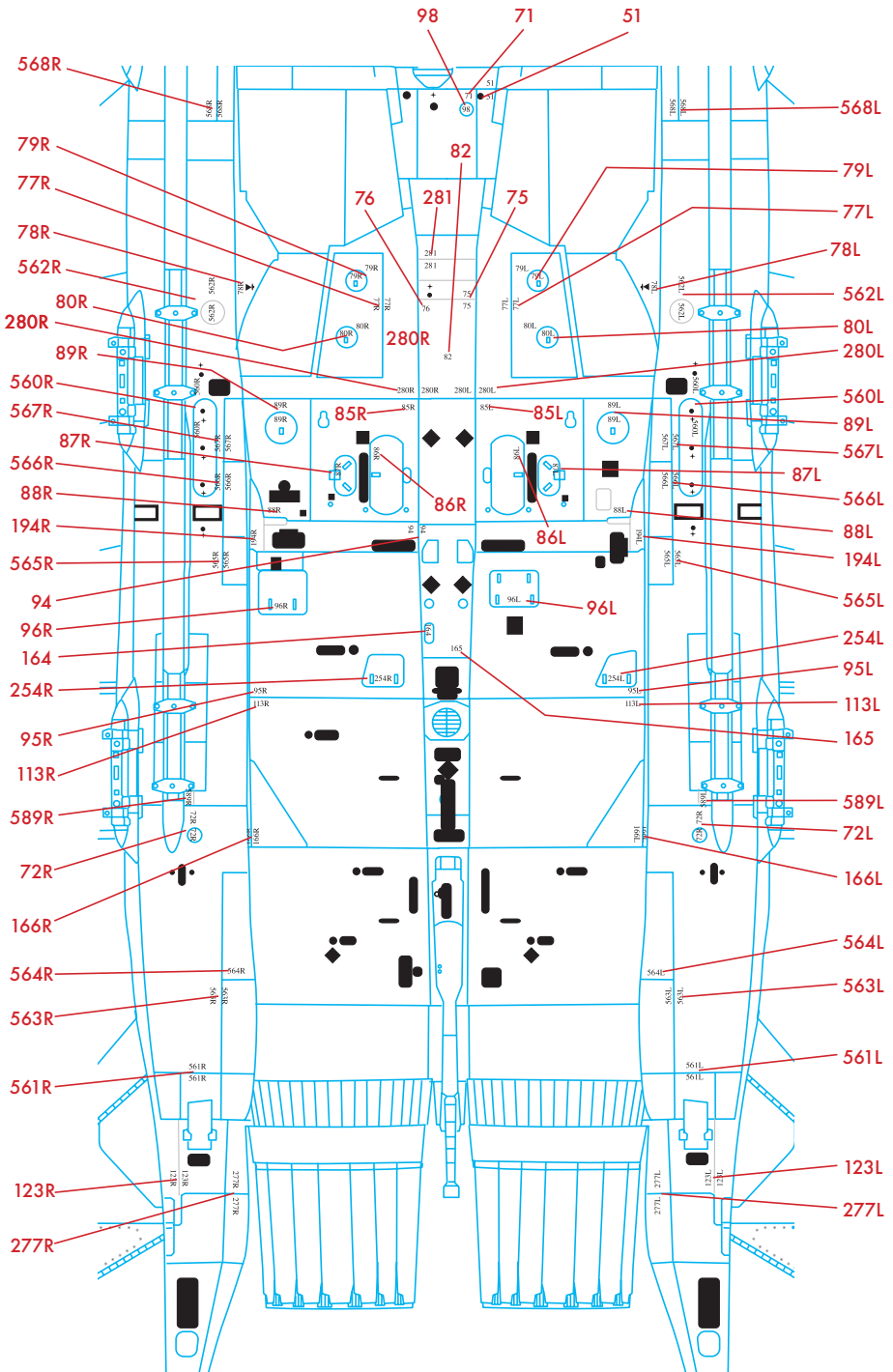

# Front bottom side - stencils placement

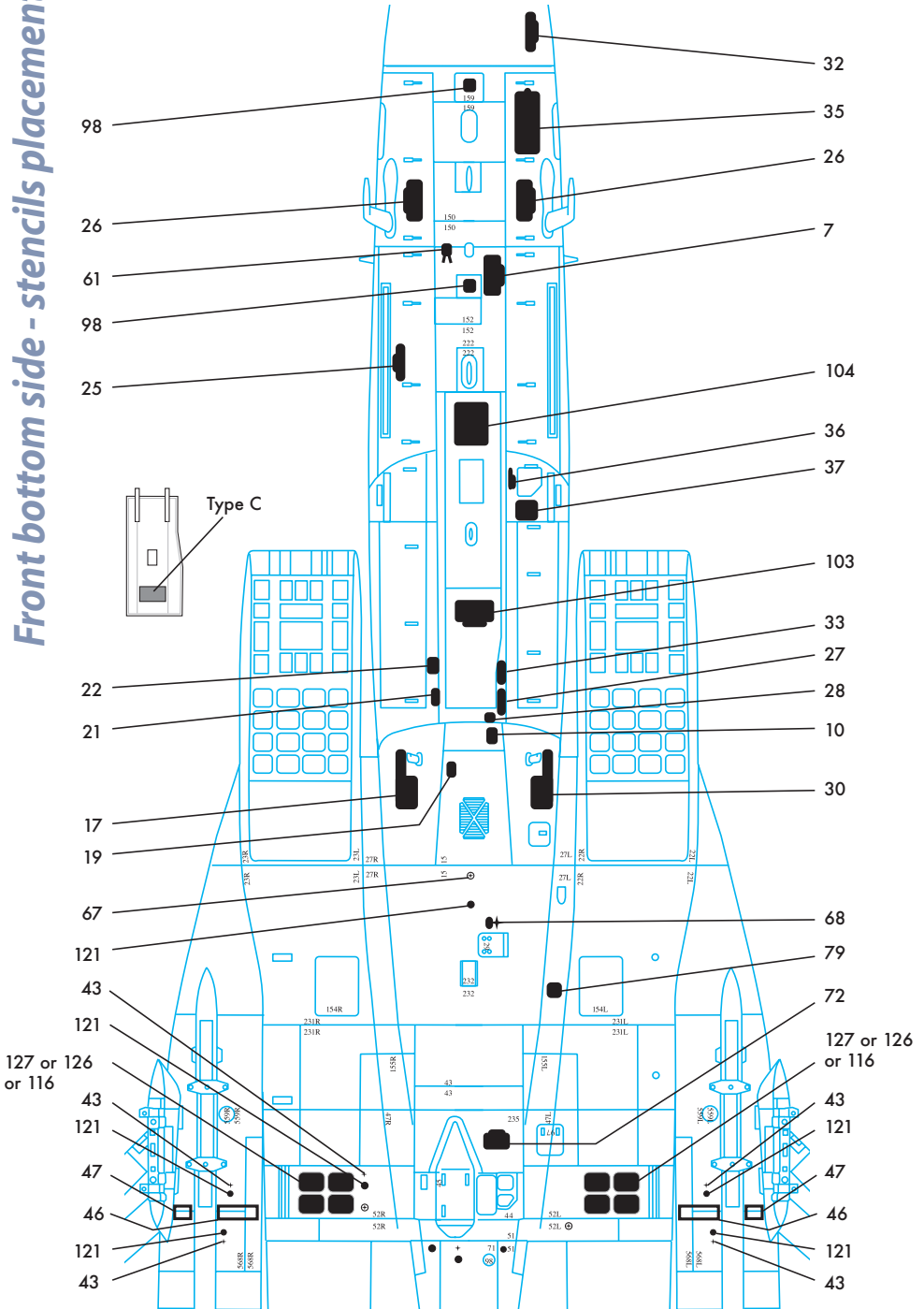

# Front bottom side - Panel numbers placement

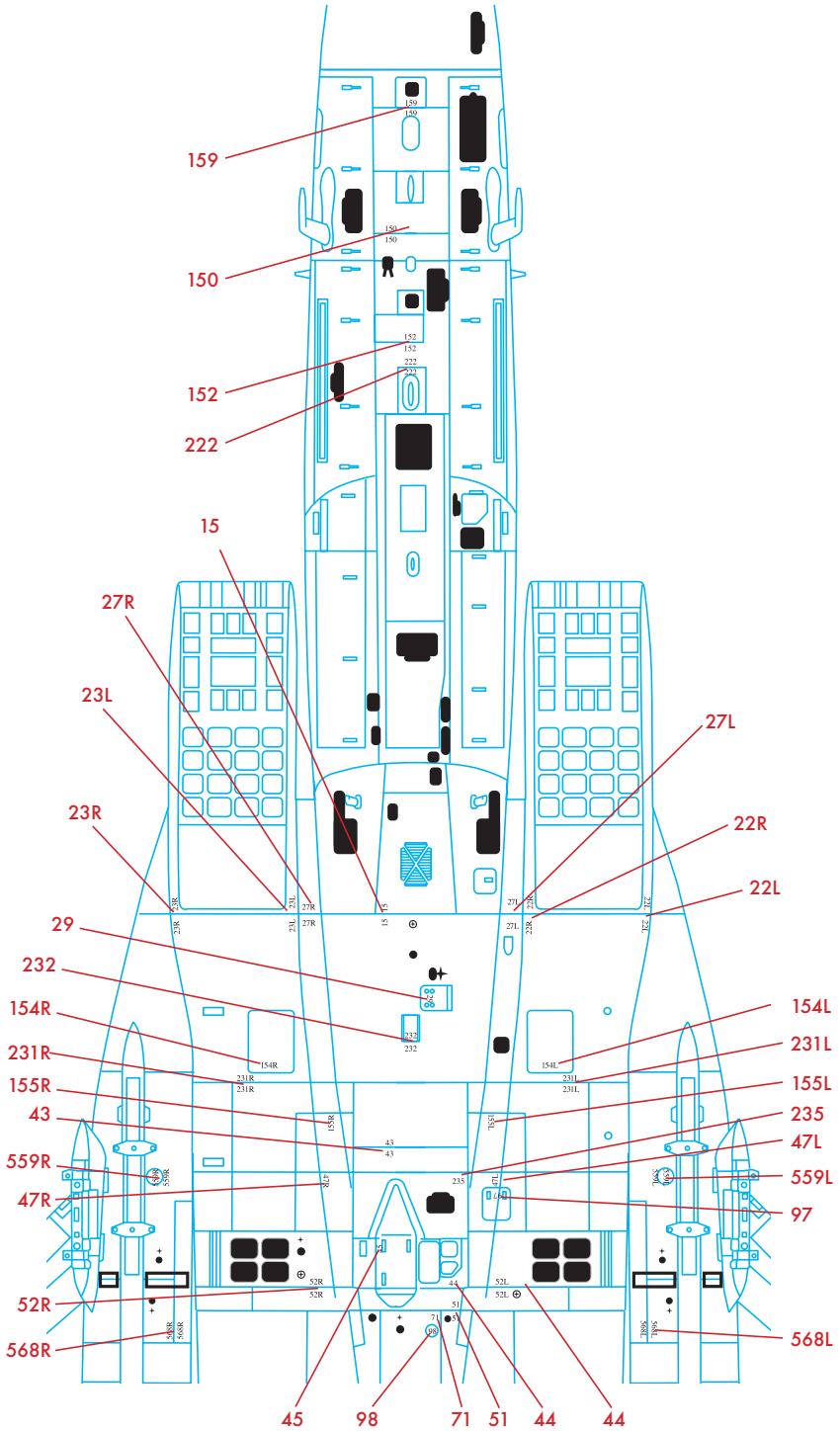

MANAT- Test and Evaluation Unit operates one F-15I numbers 201. The decal provides marking for the new tail art which was designed by Isradecal Studio in summer 2015.

Only on this aircraft the aerial refuelling area is painted inside with grey FS 36320.

The location of decals 201, 125 and 224 are vary from time to time considering the weapon tested. Check relevant photos to decide where to place them.

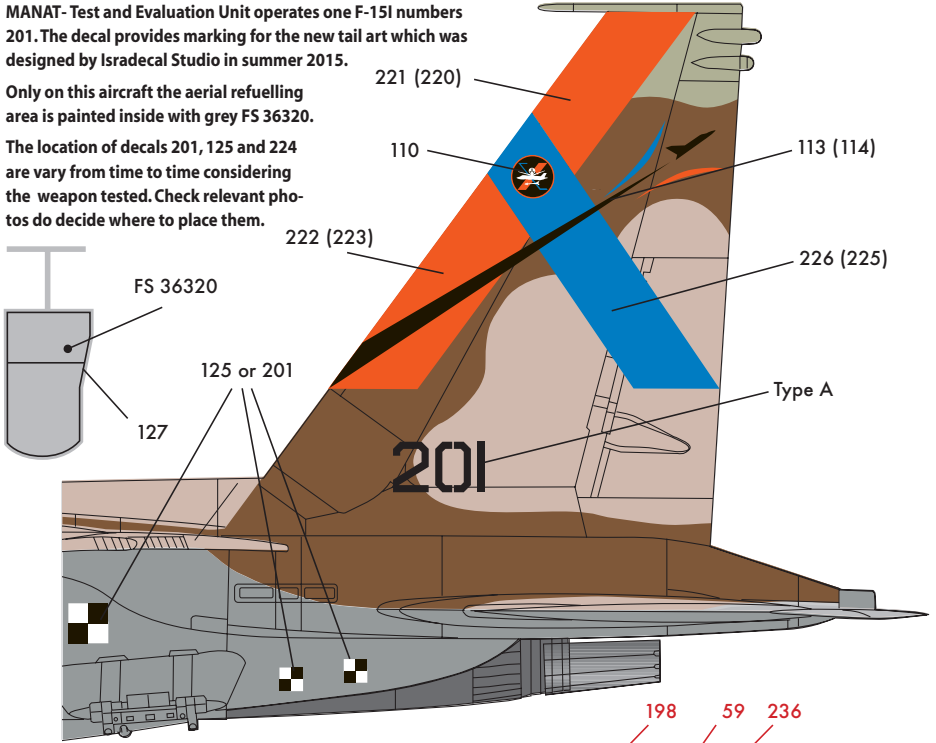

**Under the air brake**

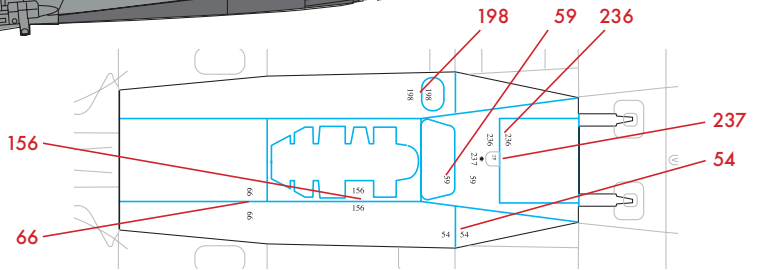

**Bottom side left stabilizer**

**Top side right stabilizer**

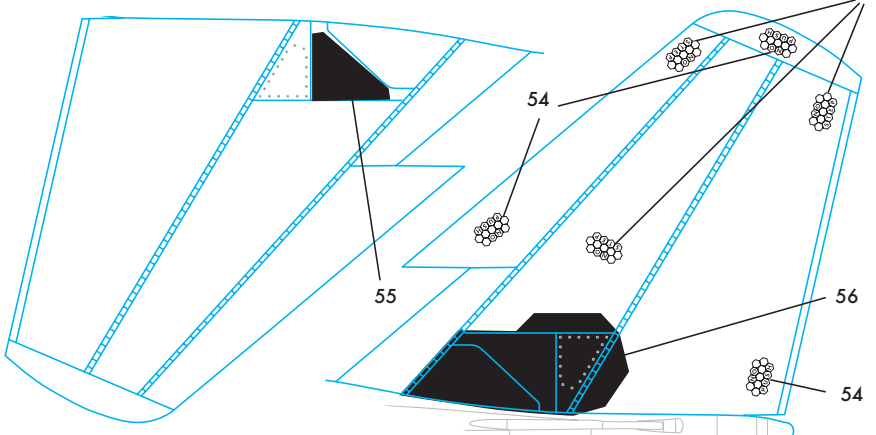

# The Hammers Sqn.

The Hammers Squadron is the only squadron that operates the F-15I Ra'am. To apply the eagle head motif on the vertical stabilizers, paint the area with sand FS 33531 as part of the camouflage colors. Allow full drying of the paint. Mask the area with the provided masking in the set and paint the rest of the aircraft with the green and brown colors. Remove the masking and apply decals 227 and 228 on top.

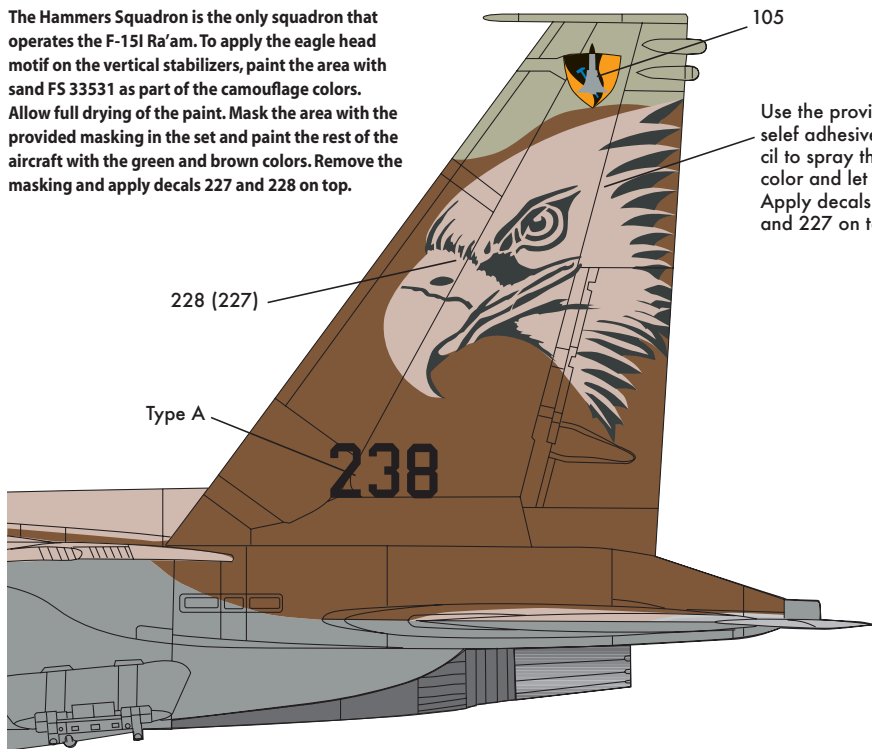

Use the provided self adhesive stencil to spray the sand color and let it dry. Apply decals 228 and 227 on top.

### Top side left stabilizer

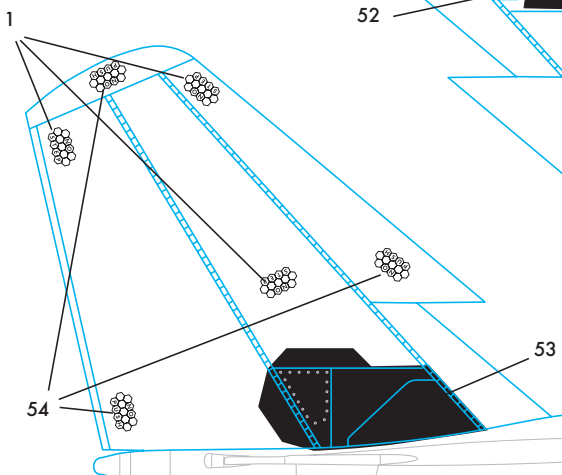

### Bottom side right stabilizer

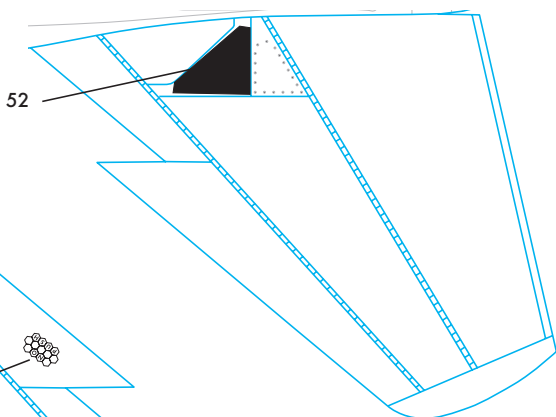



Aircraft number 238 and 227 are two of the F-15Is that participated in the attack on the Syrian nuclear plant on Deir el-Zor on September 6, 2007.







Aircraft number 263 is marked with a kill mark of a Hamas UAV shot down on February 27, 2020



Aircraft number 201 is the sole F-15I of the Test and Evaluation Unit - MANAT.

The 224, 125 and 201 markings were applying around all pylons and CFSs.





Photo: Shay Finkelman ©



Photo: Shay Finkelman ©

# General Scheme Pattern

Note: Not like in other IAF aircraft, the bottom side color, gray FS 36375, was painted after the top camouflage was painted, allowing a straight painting line on the nose section.

